

Introduction

When MARELEC launched its first PORTIO back in 2008, it answered a growing demand in the food-processing market. The machine was first introduced for fish processing, but soon after, the three-camera version was developed for the meat industry. This was the start of a successful product line that quickly developed into dedicated versions that would soon be used worldwide in all segments of the fish, meat and poultry processing industries.

Today, we are proud to present a complete range of intelligent portion cutters including the waterjet. All models have been created with a customer-centric focus and are built using the extensive expertise we have gained in food processing since the early nineties.

We kindly invite you to browse through our brochure to find out more about the different PORTIO JET models, applications and our unique selling points. Our sales team is ready to answer any questions you may have.

Regardless of which PORTIO you need, choosing MARELEC - a worldwide leader in this technology - will ensure that you are working with a service-oriented company, one that listens to your specific needs and is a flexible partner with a human approach. We look forward to a mutually profitable cooperation!

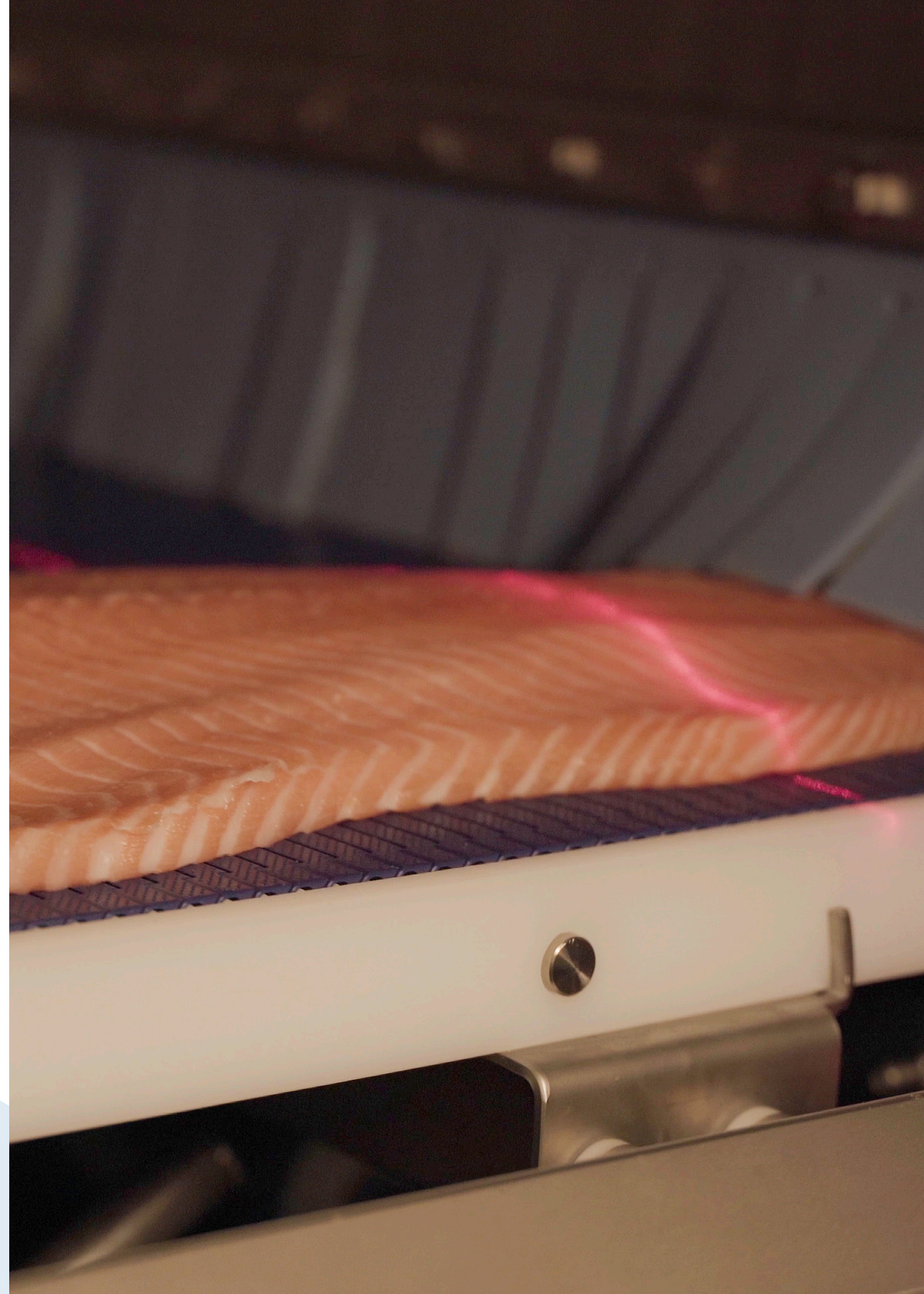

Unique Selling Points

1 // OPTIMIZED YIELD

Combining the latest vision technology with our PORTIO JET optimization software and state-of-the-art nozzles results in the highest possible yields.

2 // FLEXIBLE CUTTING ALGORITHMS

The PORTIO JET optimization software calculates which cuts have priority over others to determine the cutting pattern that results in most value.

3 // UNPARALLELED ACCURACY

The waterjet cutter PORTIO JET uses the latest vision technology, featuring a 200Hz camera that scans products such as salmon fillets or white fish fillets and converts this into a 3D model.

4 // MODULAR DESIGN FOR INCREASED CAPACITY

The base unit of our waterjet cutter consists of one scanning station and two high-pressure cutting stations - this is called the PORTIO JET 2. Depending on customer needs, the PORTIO JET 2 can be extended with additional modules, each with two high-pressure waterjet stations, up to 8 cutting stations in total.

5 // USER-FRIENDLY SOFTWARE INTERFACE

Intuitive programming of cutting patterns and fast and easy fine-tuning of the programs results in maximum yields. The cutting pattern is visible on the screen along with an indication of the thickness and the weight of every portion.

6 // EXTREMELY HYGIENIC, EASY TO CLEAN

The waterjet cutter complies with the most stringent hygiene standards. The open structure of the portioning machine allows for the pressure washing and disinfecting of all interior and exterior surfaces. All cabinets with electrics and electronics have a unique drying system to prevent condensation building up, plus our dual sealing concept on all doors.

7 // SERVICE

MARELEC has built a very strong reputation for its after sales service. Our team of service engineers is available 24/7 to reply to your queries. All machines can be connected to the internet, which allows our service team to diagnose the status of the machine from our head office. This enables us to provide you with on-the-spot assistance.



PORTIO JET

The PORTIO JET has been developed to maximize yields when cutting fish fillets into predetermined shapes of fixed weight. The camera/laser combination scans to the highest accuracy and the intelligent cutting algorithm calculates the optimal cutting pattern.

There is a list of pre-determined cutting patterns programmed, from which parameters such as weight and size of the portions can be adapted. There is also a mode where you can draw the cutting pattern on a scanned product to define specs.

Over 300 programs can be stored with a customized name, making it possible to switch cutting patterns within seconds. It's also possible to load multiple streams of products on the 600mm/24" wide belt and work with multiple applications simultaneously.

Typical applications include cutting salmon filets into fixed-weight loin portions, belly trim and tail sections. By-products can be cut into strips and cubes, and whitefish fillets can be portioned into several fixed-weight portions.

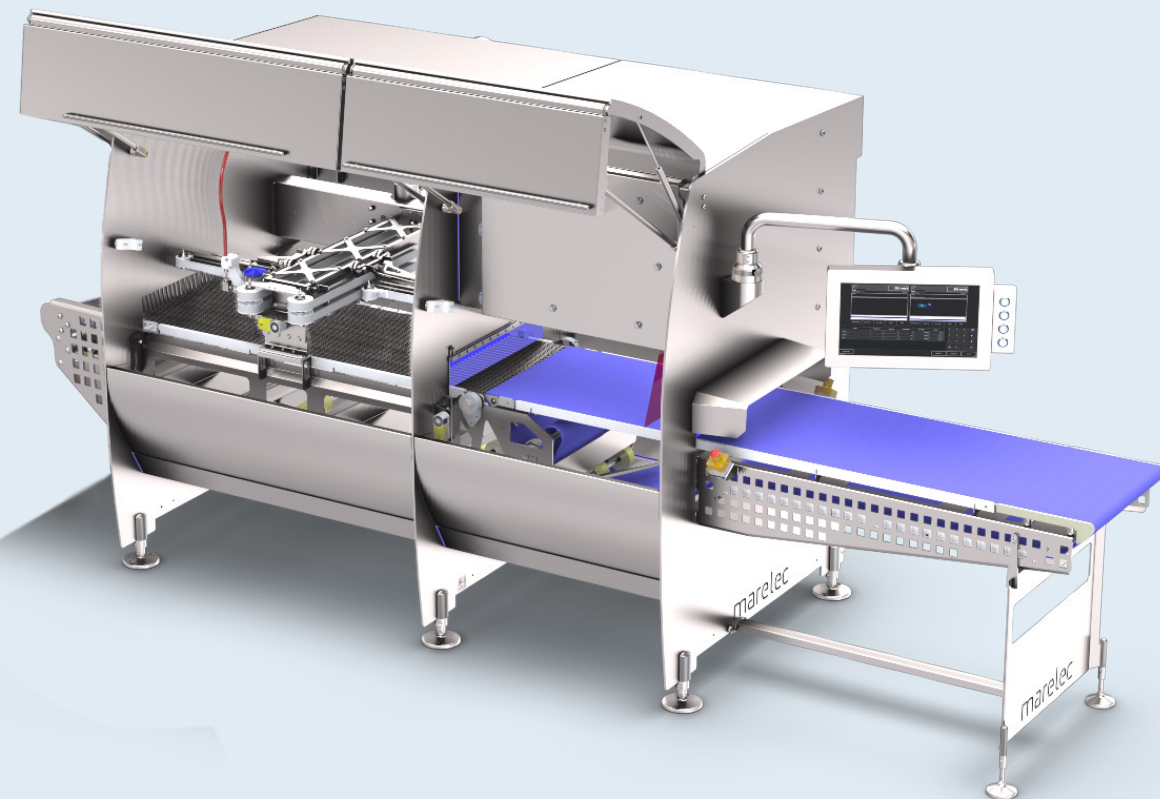

The assembly of our PORTIO JET series is modular, starting with a module in which all electronics, scanning and HMI, etc, are integrated. As standard this base unit is attached to a module with two cutting stations - a combination known as PORTIO JET 2.

This standard unit can be extended with additional modules of two high-pressure waterjet nozzles, up to eight stations in total. Thanks to the modular design, these extra stations can be added whenever your volumes require it.

The MATRIX J software collects all production data from the PORTIO JET, enabling it to generate production reports per shift or program and to trace changes at a machine level. MATRIX J software enables users to remotely create programs offline and monitor the machine status through an event log.



Overview

Applications & capacities

			PORTIO JET 2	PORTIO JET 4	PORTIO JET 6	PORTIO JET 8
Product	Raw material	Application	Capacity			
	Filletts ≈ 1,5 kg	Head trim	> 2000 kg/hour	> 4000 kg/hour	> 6000 kg/hour	> 8000 kg/hour
		Tail trim				
		Belly trim				
		Fixed portions				
	Filletts ≈ 1,25kg	Fixed portions	> 2000 kg/hour	> 4000 kg/hour	> 6000 kg/hour	> 8000 kg/hour

Specifications depend on product characteristics. Contact our sales team to find out the yield and capacity for your application.

Cutting patterns

Salmon Portions

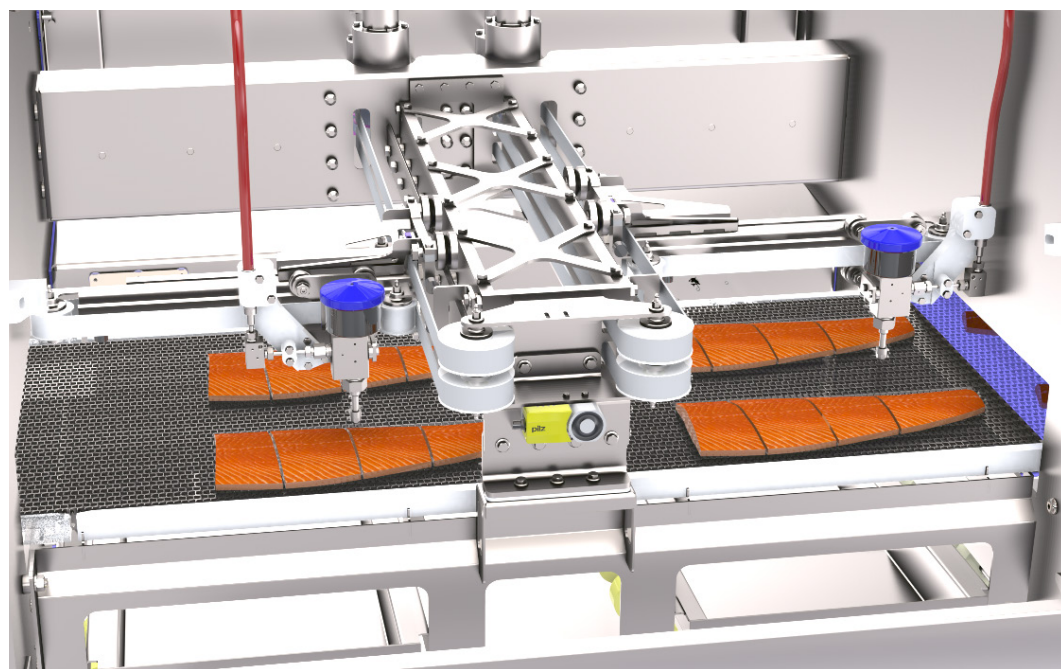
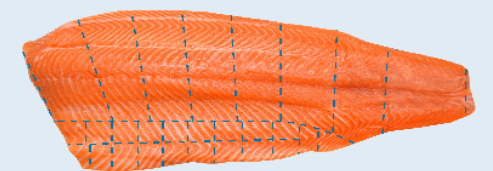
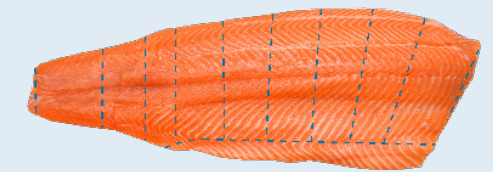
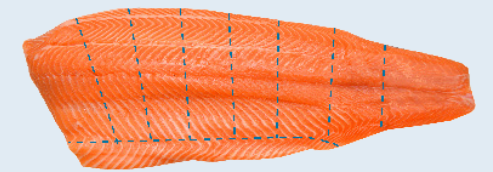

Scan to see the machine in action

Specifications

	PORTIO JET 2	PORTIO JET 4	PORTIO JET 6	PORTIO JET 8
L x W x H	4550 x 1657 x 2031 mm / 179 x 65 x 80 inch	6000 x 1657 x 2031 mm / 236 x 65 x 80 inch	7450 x 1657 x 2031 mm / 293 x 65 x 80 inch	8900 x 1657 x 2031 mm / 350 x 65 x 80 inch
Net weight	1500 kg	2000 kg	2500 kg	3000 kg
Belt width	600 mm / 24 inch			
Cutting stations	2	4	6	8
Belt speed	50 - 450 mm/s			
Power plug	3 x 400 VAC + N + PE 63A	3 x 400 VAC + N + PE 63A	3 x 400 VAC + N + PE 125A	3 x 400 VAC + N + PE 125A
Power*	40 kW	40 kW	80 kW	80 kW
Water consumption*	200 liter/hour	400 liter/hour	600 liter/hour	800 liter/hour
Maximum pressure	standard: 3800 bar optional: 6000 bar			
User-definable programs**	299			

* Depends on diameter of chosen nozzles. Contact our sales team to find out the power and water consumption for your application.

** Available programs can be expanded upon request.

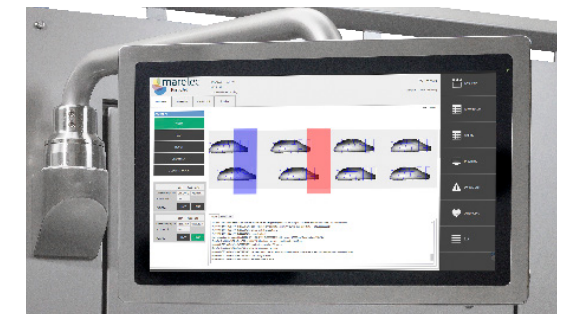
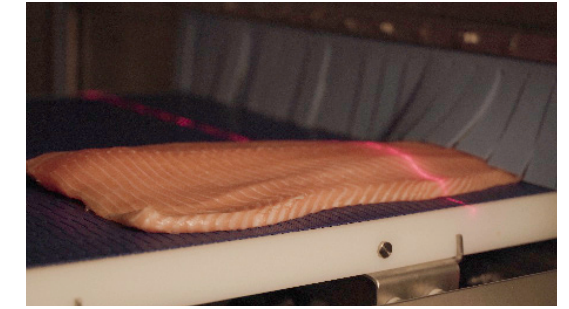
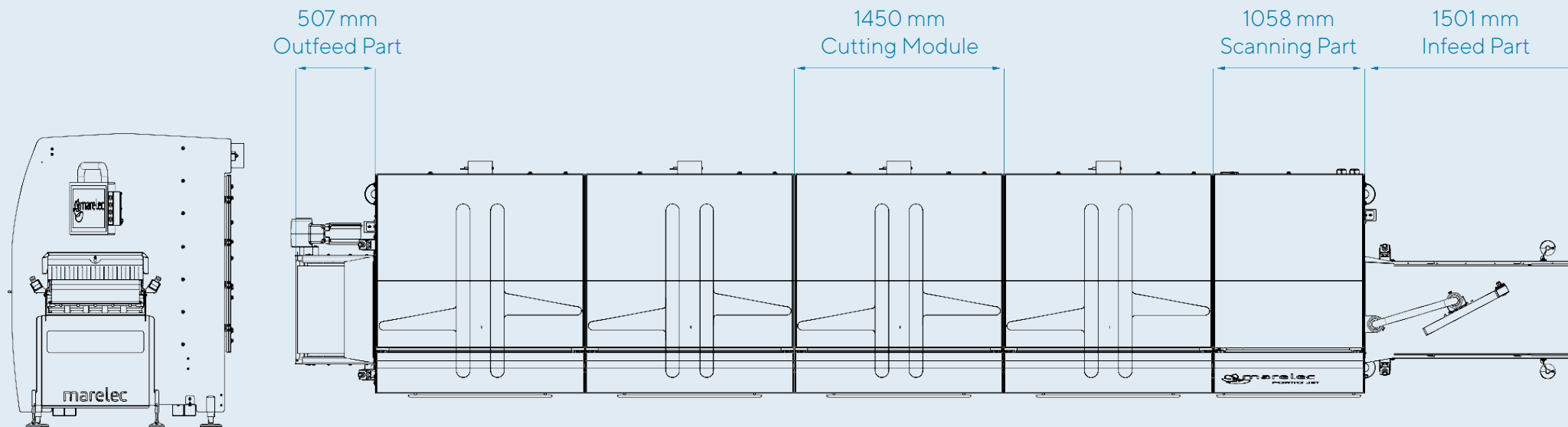



MARELEC Food Technologies
Redanweg 15 - 8620 Nieuwpoort - Belgium - T +32 58 222 111 - sales@marelec.com